

MODELS 898, 899

Dual-In-Line

Thick Film

Resistor Networks



ELECTRICAL

Standard Resistance Range, Ohms *	10 to 10Meg
Standard Resistance Tolerance, at 25°C	±2% (<33 Ohms = ±2 Ohms) Optional: ±1% (F Tol.)
Operating Temperature Range	-55°C to +125°C
Temperature Coefficient of Resistance	±100ppm/°C (<100 Ohms = ±250ppm/°C)
Temperature Coefficient of Resistance Tracking	±50ppm/°C
Maximum Operating Voltage	100Vdc or \sqrt{PR}
Insulation Resistance	≥10,000 Megohms

ENVIRONMENTAL (PER MIL-R-83401)

Thermal Shock plus Power Conditioning	ΔR 0.70%
Short Time Overload	ΔR 0.50%
Terminal Strength	ΔR 0.25%
Moisture Resistance	ΔR 0.50%
Mechanical Shock	ΔR 0.25%
Vibration	ΔR 0.25%
Low Temperature Storage	ΔR 0.25%
High Temperature Exposure	ΔR 0.50%
Load Life, 1,000 Hours	ΔR 1.00%
Resistance to Solder Heat (Per MIL-STD-202, Method 210, Cond.B)	ΔR 0.25%
Dielectric Withstanding Voltage	200V rms for 1 minute
Temperature Exposure, Maximum	215°C for 3 minutes
Marking Permanency	MIL-STD-202, Method 215
Lead Solderability	MIL-STD-202, Method 208
Flammability	UL-94V-0 Rated
Storage Temperature Range	-55°C to +125°C

* Plus "0 Ohm" jumper

Specifications subject to change without notice.

MECHANICAL

Lead Material	Copper Alloy, 60/40 Tin-Lead (Plating)
Substrate Material	Alumina
Resistor Material	Cermet

APPLICABLE DOCUMENTS

MIL-R-83401 — Resistor Networks, Fixed, Film, General Specifications
MIL-STD-105 — Sampling Procedures and Tables for Inspection by Attributes
MIL-STD-202 — Test Methods for Electronic and Electrical Component Parts

STANDARD RESISTANCE VALUES, OHMS

-3 Circuit (Isolated Resistors) & -1 Circuits (Bussed Resistors)

22	390	5.6K	100K
27	470	6.8K	120K
33	510	8.2K	150K
39	560	10K	180K
47	680	12K	200K
51	820	15K	220K
56	1K	18K	270K
68	1.2K	20K	330K
82	1.5K	22K	390K
100	1.8K	27K	470K
120	2K	33K	510K
150	2.2K	39K	560K
180	2.7K	47K	680K
200	3.3K	51K	820K
220	3.9K	56K	1Meg
270	4.7K	68K	
330	5.1K	82K	

-5 Circuit (Dual Terminators)

R1/R2	R1/R2	R1/R2	R1/R2
180/390	220/330	330/470	3K/6.2K
220/270	330/390	330/680	

POWER DISSIPATION, WATTS AT 70°C

Model	Package	Resistor (Per Circuit)		
		-1	-3	-5
898	2.0	.125	.250	.125
899	1.8	.125	.250	.125

OUTLINE DIMENSIONS (Inch/mm)

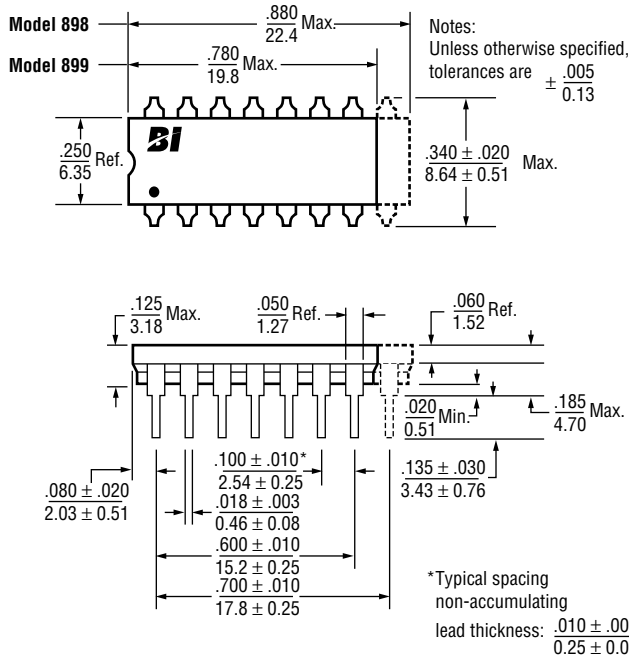

4

SCHEMATICS

-3 Circuit - Isolated Resistors

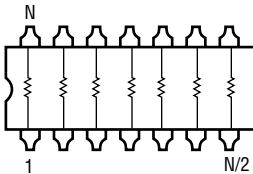

-1 Circuit - Bussed Resistors

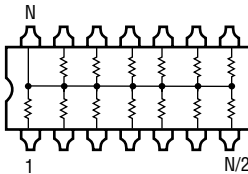

-5 Circuit - Dual Terminator

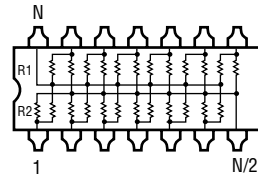

-42 Circuit - 5.2V (V_{EE}) Pull-Down

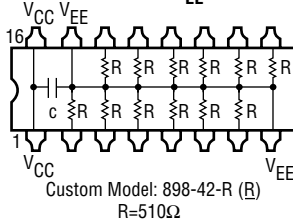

-45 Circuit - TTL to ECL Translator

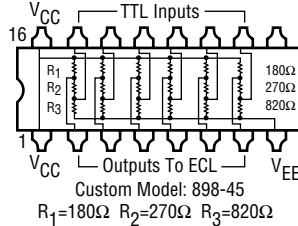

Note: Model 899: N = 114 Leads, Model 898: N = 16 Leads.
Custom circuits are available. Consult Factory.

TYPICAL PART MARKING

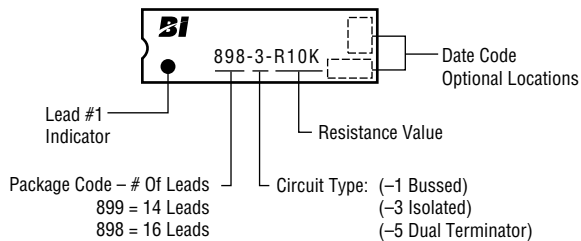

PACKAGING

Standard: Magazines

All Units oriented with lead #1 to the same side.

Magazine:	Material	=	Antistatic Plastic
	Capacity	=	25 Units

ORDERING INFORMATION

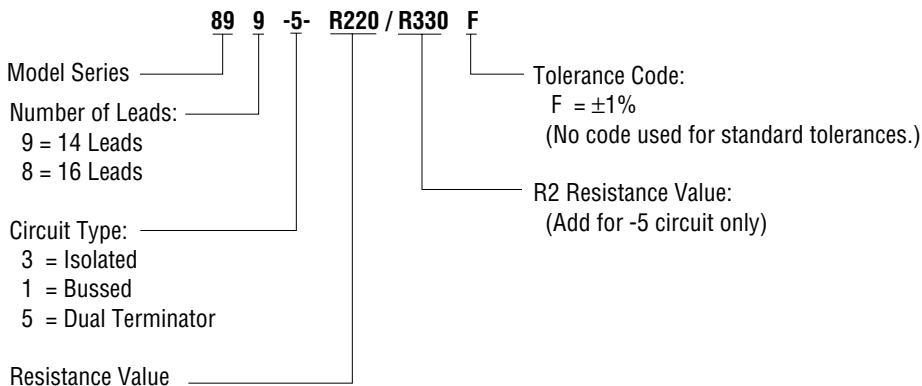

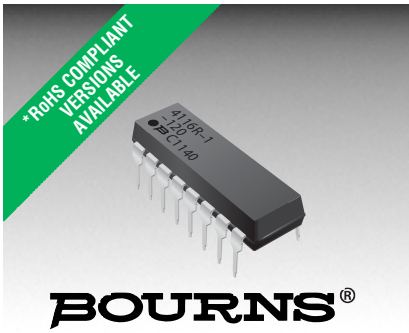

Features

- RoHS compliant* versions available (see How to Order "Termination" option)
- Compatible with automatic insertion equipment
- Superior package integrity
- Now available with improved tolerance to $\pm 0.5\%$

For information on specific applications, download Bourns' application notes:

- [DRAM Applications](#)
- [Dual Terminator Resistor Networks](#)
- [R/2R Ladder Networks](#)
- [SCSI Applications](#)

4100R Series - Thick Film Molded DIPs

Product Characteristics

Resistance Range 10 ohms to 10 megohms
 Maximum Operating Voltage 100 V
 Temperature Coefficient of Resistance
 50 Ω to 2.2 M Ω ± 100 ppm/ $^{\circ}$ C
 below 50 Ω ± 250 ppm/ $^{\circ}$ C
 above 2.2 M Ω ± 250 ppm/ $^{\circ}$ C
 TCR Tracking 50 ppm/ $^{\circ}$ C
 maximum; equal values
 Resistor Tolerance See circuits
 Operating Temperature -55 $^{\circ}$ C to +125 $^{\circ}$ C
 Insulation Resistance 10,000 megohms minimum
 Dielectric Withstanding Voltage 200 VRMS
 Lead Solderability Meet requirements of MIL-STD-202 Method 208

Environmental Characteristics

TESTS PER MIL-STD-202 ΔR MAX.
 Short Time Overload $\pm 0.25\%$
 Load Life $\pm 1.00\%$
 Moisture Resistance $\pm 0.50\%$
 Resistance to Soldering Heat $\pm 0.25\%$
 Terminal Strength $\pm 0.25\%$
 Thermal Shock $\pm 0.25\%$

Physical Characteristics

Flammability Conforms to UL94V-0
 Lead Frame Material Copper, solder coated
 Body Material Novolac epoxy

How To Order

41 14 R - 1 - 152

Model _____
 (41 = Molded DIP)
 Number of Pins _____
 Physical Configuration _____
 (R = Thick Film Low Profile)
 Electrical Configuration _____
 • 1 = Isolated
 • 2 = Bussed
 • 3 = Dual Terminator
 Resistance Code _____
 • First 2 digits are significant
 • Third digit represents the number of zeros to follow.
 Resistance Tolerance _____
 • Blank = $\pm 2\%$ (see "Resistance Tolerance" on next page for resistance range)
 • F = $\pm 1\%$ (100 ohms - 1 megohm)
 • D = $\pm 0.5\%$ (100 ohms - 1 megohm)
 Terminations _____
 • LF = Tin-plated (RoHS compliant version)
 • Blank = Tin/Lead-plated
 Consult factory for other available options.

Package Power Temp. Derating Curve

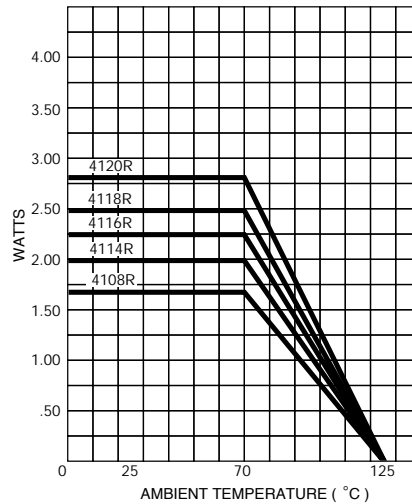

Package Power Rating at 70 °C

4108R	1.69 watts
4114R	2.00 watts
4116R	2.25 watts
4118R	2.50 watts
4120R	2.80 watts

Typical Part Marking

Represents total content. Layout may vary.

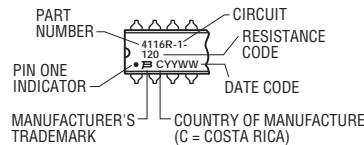

For Standard Values Used in Capacitors, Inductors, and Resistors, [click here](#).



WARNING Cancer and Reproductive Harm

www.P65Warnings.ca.gov

*RoHS Directive 2015/863, Mar 31, 2015 and Annex. Specifications are subject to change without notice. Users should verify actual device performance in their specific applications. The products described herein and this document are subject to specific legal disclaimers as set forth on the last page of this document, and at www.bourns.com/docs/legal/disclaimer.pdf

Product Dimensions

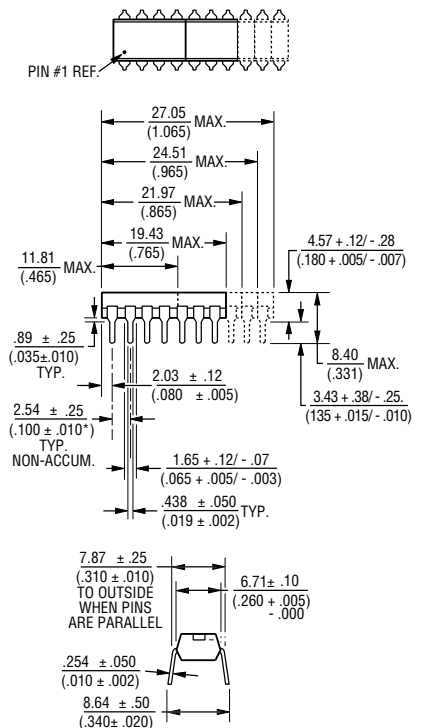

Governing dimensions are in metric. Dimensions in parentheses are inches and are approximate.

*Terminal centerline to centerline measurements made at point of emergence of the lead from the body.

4100R Series - Thick Film Molded DIPs

BOURNS®

Isolated Resistors (1 Circuit)

- Model 4108R-1-RC
(4 Isolated Resistors)
- Model 4114R-1-RC
(7 Isolated Resistors)
- Model 4116R-1-RC
(8 Isolated Resistors)
- Model 4118R-1-RC
(9 Isolated Resistors)
- Model 4120R-1-RC
(10 Isolated Resistors)

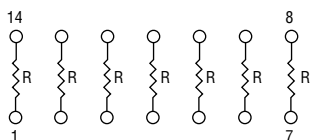

Bussed Resistors (2 Circuit)

- Model 4108R-2-RC
(7 Resistors, Pin 8 Common)
- Model 4114R-2-RC
(13 Resistors, Pin 14 Common)
- Model 4116R-2-RC
(15 Resistors, Pin 16 Common)
- Model 4118R-2-RC
(17 Resistors, Pin 18 Common)
- Model 4120R-2-RC
(19 Resistors, Pin 20 Common)

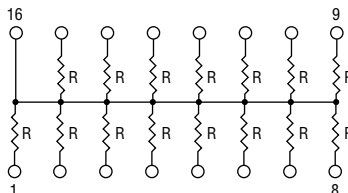

Dual Resistors (3 Circuit)

- Model 4108R-3-R1/R2
- Model 4114R-3-R1/R2
- Model 4116R-3-R1/R2 (shown)
- Model 4118R-3-R1/R2
- Model 4120R-3-R1/R2

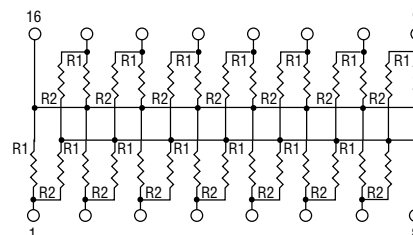

Resistance Tolerance

10 ohms to 49 ohms ± 1 ohm
 50 ohms to 5 megohms $\pm 2\%$ *
 Above 5 megohms $\pm 5\%$

Power Rating per Resistor

At 70 °C 0.250 watt

Power Temperature Derating Curve

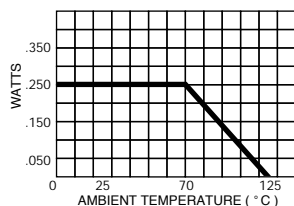

Resistance Tolerance

10 ohms to 49 ohms ± 1 ohm
 50 ohms to 5 megohms $\pm 2\%$ *
 Above 5 megohms $\pm 5\%$

Power Rating per Resistor

At 70 °C 0.125 watt

Power Temperature Derating Curve

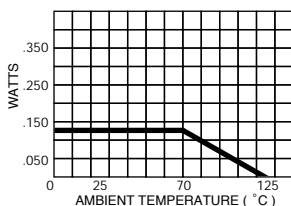

Resistance Tolerance

Below 100 ohms ± 2 ohms
 100 ohms to 5 megohms $\pm 2\%$ *
 Above 5 megohms $\pm 5\%$

Power Rating per Resistor

At 70 °C 0.125 watt

Power Temperature Derating Curve

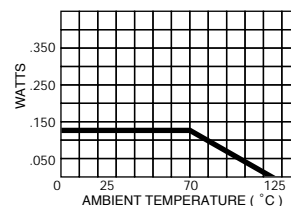

Popular Resistance Values (1, 2 Circuits)**

Ohms	Code	Ohms	Code	Ohms	Code	Ohms	Code	Ohms	Code
10	100	180	181	1,800	182	15,000	153	120,000	124
22	220	220	221	2,000	202	18,000	183	150,000	154
27	270	270	271	2,200	222	20,000	203	180,000	184
33	330	330	331	2,700	272	22,000	223	220,000	224
39	390	390	391	3,300	332	27,000	273	270,000	274
47	470	470	471	3,900	392	33,000	333	330,000	334
56	560	560	561	4,700	472	39,000	393	390,000	394
68	680	680	681	5,600	562	47,000	473	470,000	474
82	820	820	821	6,800	682	56,000	563	560,000	564
100	101	1,000	102	8,200	822	68,000	683	680,000	684
120	121	1,200	122	10,000	103	82,000	823	820,000	824
150	151	1,500	152	12,000	123	100,000	104	1,000,000	105

Popular Resistance Values (3 Circuit)**

Resistance			
Ohms		Code	
R ₁	R ₂	R ₁	R ₂
160	240	161	241
180	390	181	391
220	270	221	271
220	330	221	331
330	390	331	391
330	470	331	471
3,000	6,200	302	622

* Add "F" after resistance code for $\pm 1\%$ tolerance available from 100 Ω through 1M Ω , or add "D" after resistance code for $\pm 0.5\%$ tolerance available from 100 Ω through 1M Ω .
 Part number suffix examples: -103 = 10K Ω , $\pm 2\%$; -103F = 10K Ω , $\pm 1\%$; -103D = 10K Ω , $\pm 0.5\%$

** Non-standard values available, within resistance range.