



2K x 8 Static RAM

Features

- Automatic power-down when deselected
- CMOS for optimum speed/power
- High speed  
— 15 ns
- Low active power  
— 440 mW (commercial)  
— 550 mW (military)
- Low standby power  
— 110 mW
- TTL-compatible inputs and outputs
- Capable of withstanding greater than 2001V electrostatic discharge
- $V_{IH}$  of 2.2V

Functional Description

The CY7C128A is a high-performance CMOS static RAM organized as 2048 words by 8 bits. Easy memory expansion is provided by an active LOW chip enable ( $\overline{CE}$ ), and active LOW output enable ( $\overline{OE}$ ) and three-state drivers. The CY7C128A has an automatic power-down feature, reducing the power consumption by 83% when deselected.

Writing to the device is accomplished when the chip enable ( $\overline{CE}$ ) and write enable ( $\overline{WE}$ ) inputs are both LOW.

Data on the eight I/O pins ( $I/O_0$  through  $I/O_7$ ) is written into the memory location specified on the address pins ( $A_0$  through  $A_{10}$ ).

Reading the device is accomplished by taking chip enable ( $\overline{CE}$ ) and output enable ( $\overline{OE}$ ) LOW while write enable ( $\overline{WE}$ ) remains HIGH. Under these conditions, the contents of the memory location specified on the address pins will appear on the eight I/O pins.

The I/O pins remain in high-impedance state when chip enable ( $\overline{CE}$ ) or output enable ( $\overline{OE}$ ) is HIGH or write enable ( $\overline{WE}$ ) is LOW.

The CY7C128A utilizes a die coat to ensure alpha immunity.

Logic Block Diagram

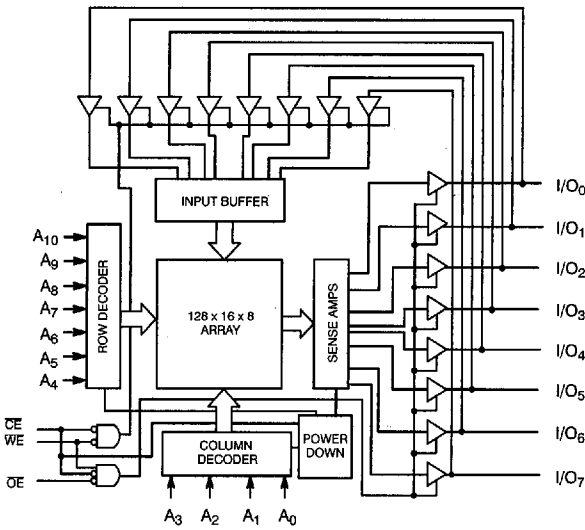

Pin Configurations

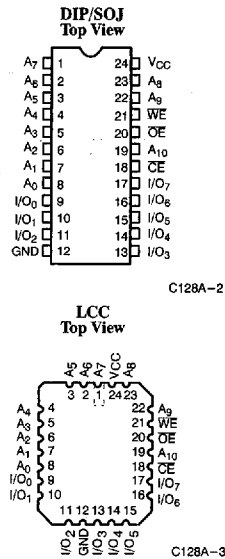

Selection Guide

		7C128A-15	7C128A-20	7C128A-25	7C128A-35	7C128A-45
Maximum Access Time (ns)		15	20	25	35	45
Maximum Operating Current (mA)	Commercial	120	100	100	100	
	Military		125	125	100	100
Maximum Standby Current (mA)	Commercial	40/40	40/20	20	20	
	Military		40/20	40	20	20

**Maximum Ratings**

(Above which the useful life may be impaired. For user guidelines, not tested.)

Storage Temperature .....	-65°C to +150°C
Ambient Temperature with Power Applied .....	-55°C to +125°C
Supply Voltage to Ground Potential (Pin 28 to Pin 14) .....	-0.5V to +7.0V
DC Voltage Applied to Outputs in High Z State .....	-0.5V to +7.0V
DC Input Voltage .....	-3.0V to +7.0V
Output Current into Outputs (LOW) .....	20 mA

Static Discharge Voltage .....	>2001V (per MIL-STD-883, Method 3015)
Latch-Up Current .....	>200 mA

**Operating Range**

Range	Ambient Temperature	V <sub>CC</sub>
Commercial	0°C to +70°C	5V ± 10%
Military <sup>[1]</sup>	-55°C to +125°C	5V ± 10%

**Electrical Characteristics** Over the Operating Range<sup>[2]</sup>

Parameter	Description	Test Conditions	7C128A-15		7C128A-20		7C128A-25		7C128A-35, 45		Unit
			Min.	Max.	Min.	Max.	Min.	Max.	Min.	Max.	
V <sub>OH</sub>	Output HIGH Voltage	V <sub>CC</sub> = Min., I <sub>OH</sub> = -4.0 mA	2.4		2.4		2.4		2.4		V
V <sub>OL</sub>	Output LOW Voltage	V <sub>CC</sub> = Min., I <sub>OL</sub> = 8.0 mA		0.4		0.4		0.4		0.4	V
V <sub>IH</sub>	Input HIGH Voltage		2.2	V <sub>CC</sub>	2.2	V <sub>CC</sub>	2.2	V <sub>CC</sub>	2.2	V <sub>CC</sub>	V
V <sub>IL</sub>	Input LOW Voltage <sup>[3]</sup>		-0.5	0.8	-0.5	0.8	-0.5	0.8	-0.5	0.8	V
I <sub>IX</sub>	Input Load Current	GND ≤ V <sub>I</sub> ≤ V <sub>CC</sub>	-10	+10	-10	+10	-10	+10	-10	+10	μA
I <sub>OZ</sub>	Output Leakage Current	GND ≤ V <sub>I</sub> ≤ V <sub>CC</sub> Output Disabled	-10	+10	-10	+10	-10	+10	-10	+10	μA
I <sub>OS</sub>	Output Short Circuit Current <sup>[4]</sup>	V <sub>CC</sub> = Max., V <sub>OUT</sub> = GND		-300		-300		-300		-300	mA
I <sub>CC</sub>	V <sub>CC</sub> Operating Supply Current	V <sub>CC</sub> = Max. I <sub>OUT</sub> = 0 mA	Com'l	120		100		100		100	mA
			Mil				125		125		
I <sub>SB1</sub>	Automatic $\overline{CE}$ Power-Down Current	Max. V <sub>CC</sub> , $\overline{CE} \geq V_{IH}$ , Min. Duty Cycle = 100%	Com'l	40		40		20		20	mA
			Mil				40		40		
I <sub>SB2</sub>	Automatic $\overline{CE}$ Power-Down Current	Max. V <sub>CC</sub> , $\overline{CE}_1 \geq V_{CC} - 0.3V$ , V <sub>IN</sub> ≥ V <sub>CC</sub> - 0.3V or V <sub>IN</sub> ≤ 0.3V	Com'l	40		20		20		20	mA
			Mil				20		20		

**Capacitance<sup>[5]</sup>**

Parameter	Description	Test Conditions	Max.	Unit
C <sub>IN</sub>	Input Capacitance	T <sub>A</sub> = 25°C, f = 1 MHz, V <sub>CC</sub> = 5.0V	10	pF
C <sub>OUT</sub>	Output Capacitance		10	pF

**Notes:**

1. T<sub>A</sub> is the "instant on" case temperature.
2. See the last page of this specification for Group A subgroup testing information.
3. V<sub>IL</sub> (min.) = -3.0V for pulse durations less than 30 ns.
4. Not more than 1 output should be shorted at one time. Duration of the short circuit should not exceed 30 seconds.
5. Tested initially and after any design or process changes that may affect these parameters.

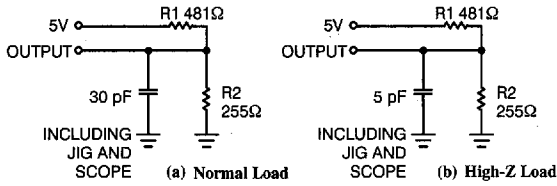
**AC Test Loads and Waveforms**

C128A-4

C128A-5

Equivalent to: THÉVENIN EQUIVALENT

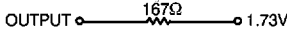
**Switching Characteristics Over the Operating Range<sup>[2, 6]</sup>**

Parameter	Description	7C128A-15		7C128A-20		7C128A-25		7C128A-35		7C128A-45		Unit
		Min.	Max.	Min.	Max.	Min.	Max.	Min.	Max.	Min.	Max.	
<b>READ CYCLE</b>												
$t_{RC}$	Read Cycle Time	15		20		25		35		45		ns
$t_{AA}$	Address to Data Valid		15		20		25		35		45	ns
$t_{OHA}$	Data Hold from Address Change	5		5		5		5		5		ns
$t_{ACE}$	$\overline{CE}$ LOW to Data Valid		15		20		25		35		45	ns
$t_{DOE}$	$\overline{OE}$ LOW to Data Valid		10		10		12		15		20	ns
$t_{LZOE}$	$\overline{OE}$ LOW to Low Z	3		3		3		3		3		ns
$t_{HZOE}$	$\overline{OE}$ HIGH to High Z <sup>[7]</sup>		8		8		10		12		15	ns
$t_{LZCE}$	$\overline{CE}$ LOW to Low Z <sup>[8]</sup>	5		5		5		5		5		ns
$t_{HZCE}$	$\overline{CE}$ HIGH to High Z <sup>[7, 8]</sup>		8		8		10		15		15	ns
$t_{PU}$	$\overline{CE}$ LOW to Power-Up	0		0		0		0		0		ns
$t_{PD}$	$\overline{CE}$ HIGH to Power-Down		15		20		20		20		25	ns
<b>WRITE CYCLE<sup>[9]</sup></b>												
$t_{WC}$	Write Cycle Time	15		20		20		25		40		ns
$t_{SCE}$	$\overline{CE}$ LOW to Write End	12		15		20		25		30		ns
$t_{AW}$	Address Set-Up to Write End	12		15		20		25		30		ns
$t_{HA}$	Address Hold from Write End	0		0		0		0		0		ns
$t_{SA}$	Address Set-Up to Write Start	0		0		0		0		0		ns
$t_{PWE}$	$\overline{WE}$ Pulse Width	12		15		15		20		20		ns
$t_{SD}$	Data Set-Up to Write End	10		10		10		15		15		ns
$t_{HD}$	Data Hold from Write End	0		0		0		0		0		ns
$t_{HZWE}$	$\overline{WE}$ LOW to High Z <sup>[7]</sup>		7		7		7		10		15	ns
$t_{LZWE}$	$\overline{WE}$ HIGH to Low Z	5		5		5		5		5		ns

**Note:**

- Test conditions assume signal transition time of 5 ns or less, timing reference levels of 1.5V, input pulse levels of 0 to 3.0V, and output loading of the specified  $I_{OL}/I_{OH}$  and 30-pF load capacitance.
- $t_{HZOE}$ ,  $t_{HZCE}$ , and  $t_{HZWE}$  are specified with  $C_L = 5$  pF as in part (b) of AC Test Loads. Transition is measured  $\pm 500$  mV from steady state voltage.
- At any given temperature and voltage condition,  $t_{HZCE}$  is less than  $t_{LZCE}$  for any given device.
- The internal write time of the memory is defined by the overlap of  $\overline{CE}$  LOW and  $\overline{WE}$  LOW. Both signals must be LOW to initiate a write and either signal can terminate a write by going HIGH. The data input set-up and hold timing should be referenced to the rising edge of the signal that terminates the write.

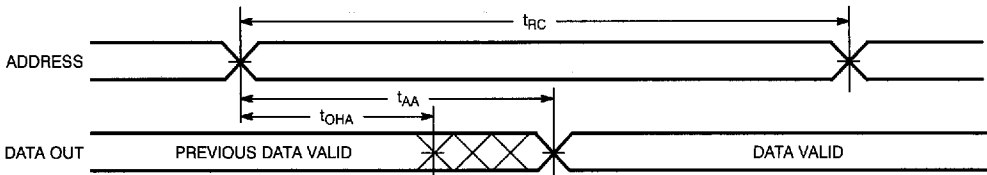
**Switching Waveforms**
**Read Cycle No. 1<sup>[10, 11]</sup>**

C128A-6

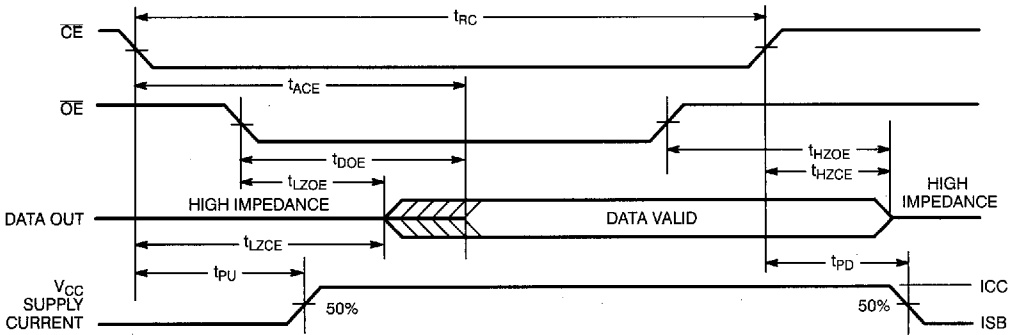
**Read Cycle No. 2<sup>[10, 12]</sup>**

C128A-7

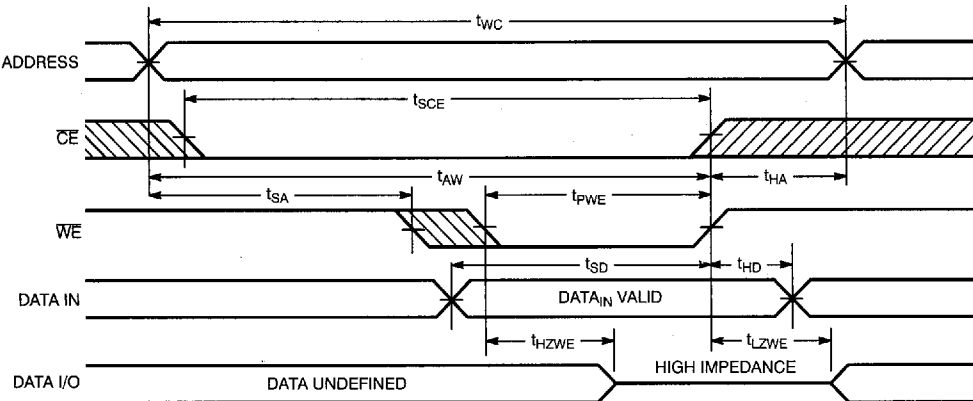
**Write Cycle No. 1 ( $\overline{WE}$  Controlled)<sup>[9, 13]</sup>**

C128A-8

**Notes:**

10.  $\overline{WE}$  is HIGH for read cycle.
11. Device is continuously selected.  $\overline{OE}, \overline{CE} = V_{IL}$ .
12. Address valid prior to or coincident with  $\overline{CE}$  transition LOW.
13. Data I/O pins enter high-impedance state, as shown, when  $\overline{OE}$  is held LOW during write.

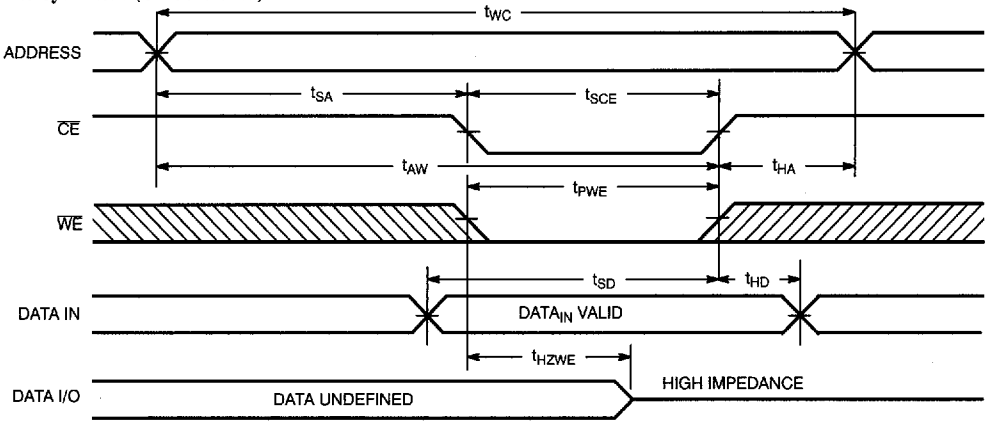
**Switching Waveforms (continued)**
**Write Cycle No. 2 ( $\overline{CE}$  Controlled)<sup>[9, 13, 14]</sup>**

C128A-9

**Note:**

 14. If  $\overline{CE}$  goes HIGH simultaneously with  $\overline{WE}$  HIGH, the output remains in a high-impedance state.

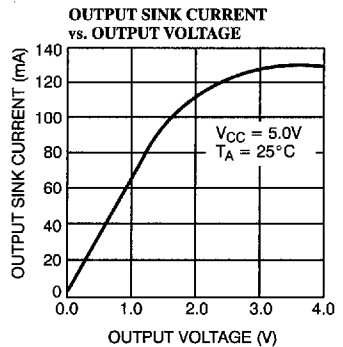
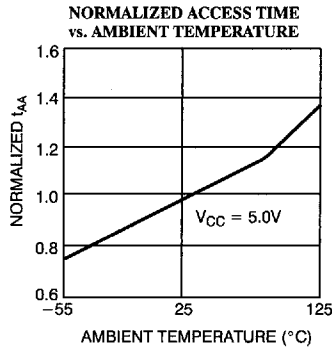
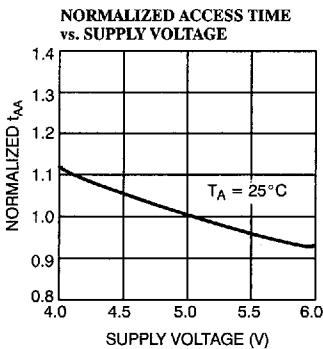
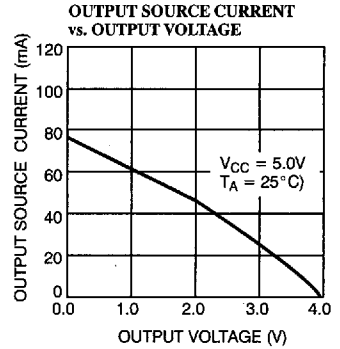
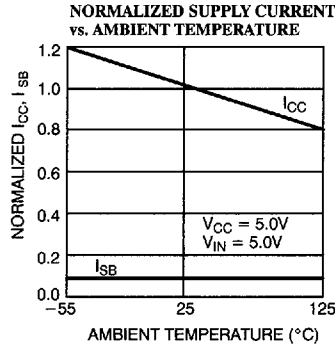
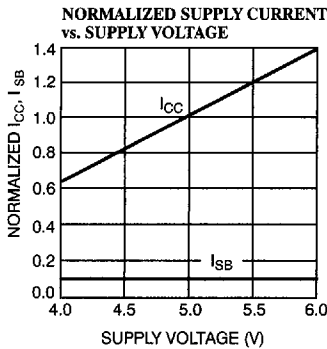
**Typical DC and AC Characteristics**

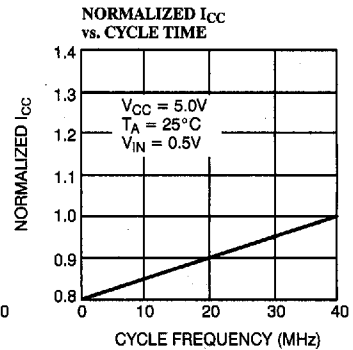
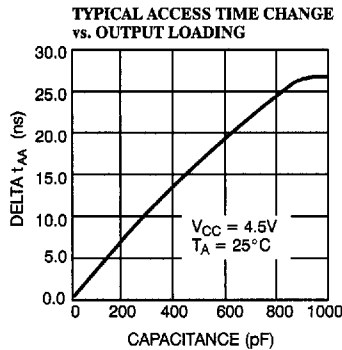
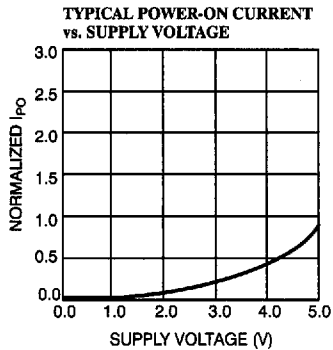
**Typical DC and AC Characteristics (continued)**

**Ordering Information**

Speed (ns)	Ordering Code	Package Name	Package Type	Operating Range
15	CY7C128A-15PC	P13	24-Lead (300-Mil) Molded DIP	Commercial
	CY7C128A-15VC	V13	24-Lead Molded SOJ	
20	CY7C128A-20PC	P13	24-Lead (300-Mil) Molded DIP	Commercial
	CY7C128A-20VC	V13	24-Lead Molded SOJ	
	CY7C128A-20DMB	D14	24-Lead (300-Mil) CerDIP	Military
	CY7C128A-20LMB	L53	24-Pin Rectangular Leadless Chip Carrier	
25	CY7C128A-25PC	P13	24-Lead (300-Mil) Molded DIP	Commercial
	CY7C128A-25VC	V13	24-Lead Molded SOJ	
	CY7C128A-25DMB	D14	24-Lead (300-Mil) CerDIP	Military
	CY7C128A-25LMB	L53	24-Pin Rectangular Leadless Chip Carrier	
35	CY7C128A-35PC	P13	24-Lead (300-Mil) Molded DIP	Commercial
	CY7C128A-35VC	V13	24-Lead Molded SOJ	
	CY7C128A-35DMB	D14	24-Lead (300-Mil) CerDIP	Military
	CY7C128A-35LMB	L53	24-Pin Rectangular Leadless Chip Carrier	
45	CY7C128A-45DMB	D14	24-Lead (300-Mil) CerDIP	Military
	CY7C128A-45LMB	L53	24-Pin Rectangular Leadless Chip Carrier	

**MILITARY SPECIFICATIONS**
**Group A Subgroup Testing**
**DC Characteristics**

Parameter	Subgroups
V <sub>OH</sub>	1, 2, 3
V <sub>OL</sub>	1, 2, 3
V <sub>IH</sub>	1, 2, 3
V <sub>IL</sub> Max.	1, 2, 3
I <sub>Ix</sub>	1, 2, 3
I <sub>OZ</sub>	1, 2, 3
I <sub>CC</sub>	1, 2, 3
I <sub>SB</sub>	1, 2, 3

**Switching Characteristics**

Parameter	Subgroups
<b>READ CYCLE</b>	
t <sub>RC</sub>	7, 8, 9, 10, 11
t <sub>AA</sub>	7, 8, 9, 10, 11
t <sub>OHA</sub>	7, 8, 9, 10, 11
t <sub>ACE</sub>	7, 8, 9, 10, 11
t <sub>DOE</sub>	7, 8, 9, 10, 11
<b>WRITE CYCLE</b>	
t <sub>WC</sub>	7, 8, 9, 10, 11
t <sub>SCE</sub>	7, 8, 9, 10, 11
t <sub>AW</sub>	7, 8, 9, 10, 11
t <sub>HA</sub>	7, 8, 9, 10, 11
t <sub>SA</sub>	7, 8, 9, 10, 11
t <sub>PWE</sub>	7, 8, 9, 10, 11
t <sub>SD</sub>	7, 8, 9, 10, 11
t <sub>HD</sub>	7, 8, 9, 10, 11

Document #: 38-00094-B