

GENERAL PURPOSE APPLICATIONS

DESCRIPTION

The BCY70, BCY71 and BCY72 are silicon planar epitaxial PNP transistors in Jedec TO-18 metal case.

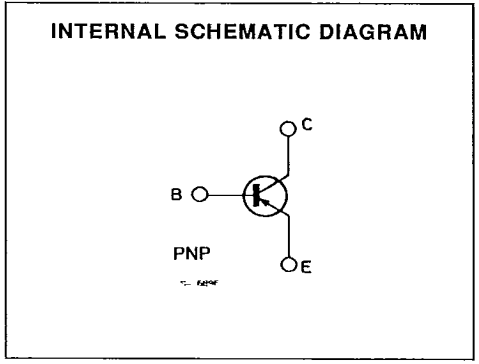
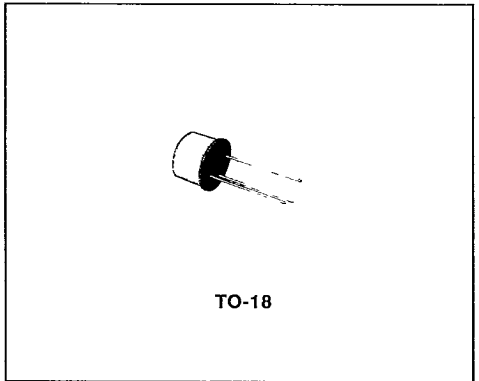

ABSOLUTE MAXIMUM RATINGS

Symbol	Parameter	Value			Unit
		BCY70	BCY71	BCY72	
V _{CBO}	Collector-base Voltage (I _E = 0)	- 50	- 45	- 25	V
V _{CEO}	Collector-emitter Voltage (I _B = 0)	- 40	- 45	- 25	V
V _{EBO}	Emitter-base Voltage (I _C = 0)	- 5			V
I _{CM}	Collector Peak Current	- 200			mA
P _{tot}	Total Power Dissipation at T _{amb} ≤ 25 °C	350			mW
T _{stg} , T _J	Storage and Junction Temperature	- 65 to 200			°C

* Pulsed : pulse duration = 300 μs, duty cycle = 1 %.

HERMAL DATA

$R_{th j-case}$	Thermal Resistance Junction-case	Max	150	$^{\circ}C/W$
$R_{th j-amb}$	Thermal Resistance Junction-ambient	Max	500	$^{\circ}C/W$

ELECTRICAL CHARACTERISTICS ($T_{amb} = 25^{\circ}C$ unless otherwise specified)

Symbol	Parameter	Test Conditions	Min.	Typ.	Max.	Unit
I_{CES}	Collector Cutoff Current ($V_{BE} = 0$)	For BCY70 $V_{CE} = -20 V$ $V_{CE} = -50 V$ For BCY71 $V_{CB} = -20 V$ $V_{CB} = -45 V$ For BCY72 $V_{CB} = -20 V$ $V_{CB} = -25 V$			-10 -500 -100 -10 -100 -10	nA nA nA μA nA μA
I_{EBO}	Emitter cutoff Current ($I_C = 0$)	$V_{EB} = -5 V$			-10	μA
$V_{CE(sat)}^*$	Collector-emitter Saturation Voltage	$I_C = -10 mA$ $I_B = -1 mA$ $I_C = -50 mA$ $I_B = -5 mA$			-0.25 -0.5	V V
$V_{BE(sat)}^*$	Base-Emitter Saturation Voltage	$I_C = -10 mA$ $I_B = -1 mA$ For BCY70 and BCY71 Only $I_C = -50 mA$ $I_B = -5 mA$	-0.6		-0.9 -1.2	V V
h_{FE}^*	DC Current Gain	For BCY70 $I_C = -0.1 mA$ $V_{CE} = -1 V$ $I_C = -1 mA$ $V_{CE} = -1 V$ $I_C = -10 mA$ $V_{CE} = -1 V$ $I_C = -50 mA$ $V_{CE} = -1 V$ For BCY71 $I_C = -0.01 mA$ $V_{CE} = -1 V$ $I_C = -0.1 mA$ $V_{CE} = -1 V$ $I_C = -1 mA$ $V_{CE} = -1 V$ $I_C = -10 mA$ $V_{CE} = -1 V$ $I_C = -50 mA$ $V_{CE} = -1 V$ For BCY72 $I_C = -1 mA$ $V_{CE} = -1 V$ $I_C = -10 mA$ $V_{CE} = -1 V$	40 45 50 15 80 90 100 15	60	600	
h_{fe}	Small Signal Current Gain (for BCY71 only)	$I_C = -1 mA$ $V_{CE} = -10 V$ $f = 1 kHz$	100		400	
f_T	Transition Frequency	$I_C = -0.1 mA$ $V_{CE} = -20 V$ $f = 10.7 MHz$ For BCY71 $I_C = -10 mA$ $V_{CE} = -20 V$ $f = 100 MHz$ For BCY70 For BCY70 and BCY72	15 250 200			MHz MHz MHz
C_{EBO}	Emitter-base Capacitance	$I_C = 0$ $V_{EB} = -1 V$ $f = 1 MHz$			8	pF
C_{CBO}	Collector-base Capacitance	$I_E = 0$ $V_{CB} = -10 V$ $f = 1 MHz$			6	pF

* Pulsed : pulse duration = 300 μs , duty cycle = 1 %.

ELECTRICAL CHARACTERISTICS (continued)

Symbol	Parameter	Test Conditions	Min.	Typ.	Max.	Unit
NF	Noise Figure	$I_C = -0.1 \text{ mA}$ $V_{CE} = -5 \text{ V}$ $R_g = 2 \text{ k}\Omega$ $f = 10 \text{ to } 10\,000 \text{ Hz}$ For BCY70 and BCY72 for BCY71			6 2	dB dB
h_{ie}	Input Impedance (for BCY71 only)	$I_C = -1 \text{ mA}$ $V_{CE} = -10 \text{ V}$ $f = 1 \text{ kHz}$	2		12	$\text{k}\Omega$
h_{re}	Reverse Voltage Ratio (for BCY71 only)	$I_C = -1 \text{ mA}$ $V_{CE} = -10 \text{ V}$ $f = 1 \text{ kHz}$			20×10^{-4}	
h_{oe}	Output Admittance (for BCY71 only)	$I_C = -1 \text{ mA}$ $V_{CE} = -10 \text{ V}$ $f = 1 \text{ kHz}$	10		60	μS
t_d	Delay Time (for BCY70 and BCY72 only)	$I_C = -10 \text{ mA}$ $V_{EE} = 3 \text{ V}$ $I_{B1} = -1 \text{ mA}$		23	35	ns
t_r	Rise Time (for BCY70 and BCY72 only)	$I_C = -10 \text{ mA}$ $V_{EE} = 3 \text{ V}$ $I_{B1} = -1 \text{ mA}$		25	35	ns
t_s	Storage Time (for BCY70 and BCY72 only)	$I_C = -10 \text{ mA}$ $V_{EE} = 3 \text{ V}$ $I_{B1} = -I_{B2} = -1 \text{ mA}$		270	350	ns
t_f	Fall Time (for BCY70 and BCY72 only)	$I_C = -10 \text{ mA}$ $V_{EE} = 3 \text{ V}$ $I_{B1} = -I_{B2} = -1 \text{ mA}$		50	80	ns
t_{on}	Turn-on Time (for BCY70 and BCY72 only)	$I_C = -10 \text{ mA}$ $V_{EE} = 3 \text{ V}$ $I_{B1} = -1 \text{ mA}$		48	65	ns
t_{off}	Turn-off Time (for BCY70 and BCY72 only)	$I_C = -10 \text{ mA}$ $V_{EE} = 3 \text{ V}$ $I_{B1} = -I_{B2} = -1 \text{ mA}$		320	420	ns

* Pulsed : pulse duration = 300 μs , duty cycle = 1 %.

TEST CIRCUIT

Test Circuit for Switching Times.

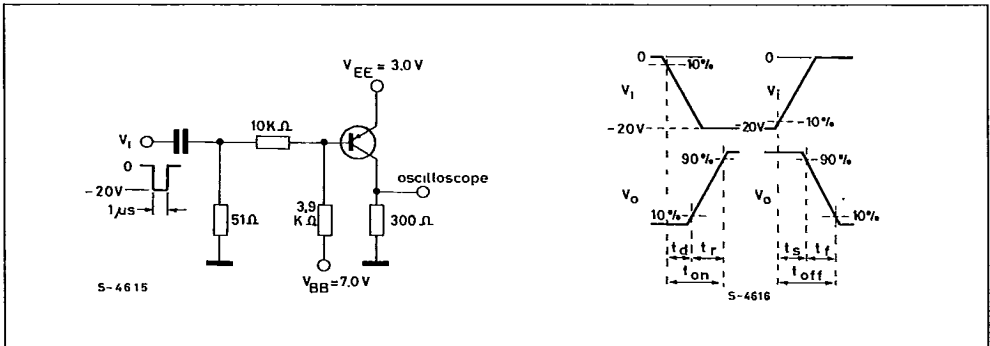

Collector-emitter Saturation Voltage.

Base-emitter Saturation Voltage.

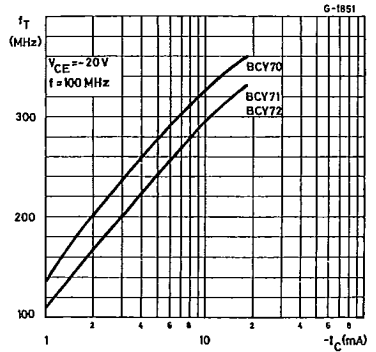
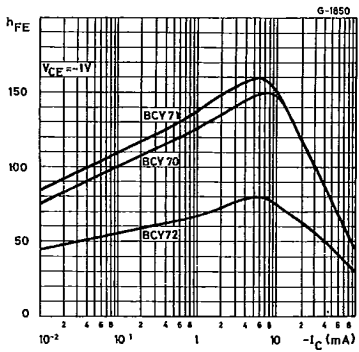
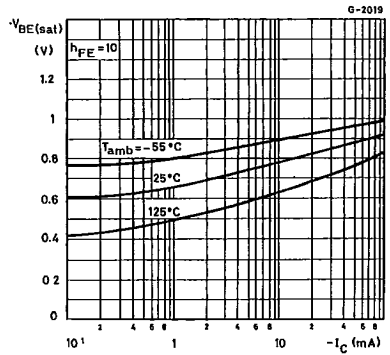
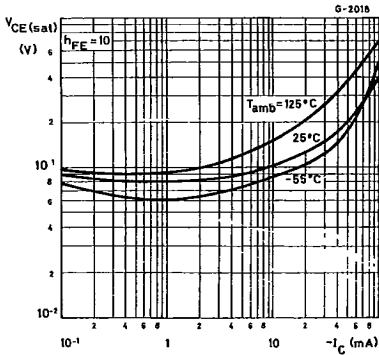

Collector-base Capacitance.

Equivalent Input Noise Voltage (for BCY71 only).

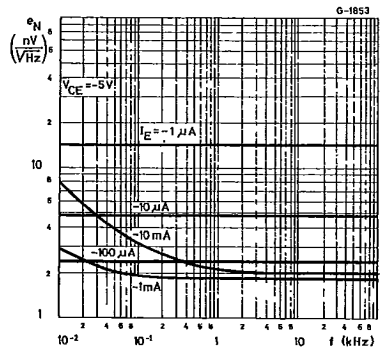
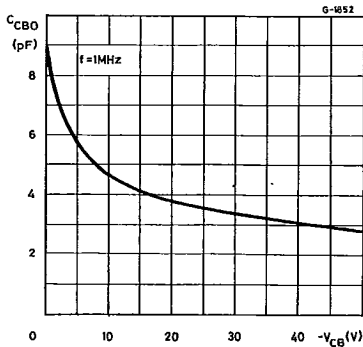

SGS-THOMSON

T-27-09

Equivalent Input Noise Current (for BCY71 only).

Contours of Constant White Noise Figure (for BCY71 only).

