





Shape	Part No.		Chip		Wave Length λ p(nm)	Electro-Optical Characteristics			Fig.No.
	Common Cathode	Common Anode	Raw Material	Emitted Color		Vf(V)20mA		Iv(ucd)10mA	
						Typ.	Max.	Typ.	
	C-302H	A-302H	GaP	Red	700	2.3	2.8	550	D25
	C-302E	A-302E	GaAsP/GaP	Hi.effi Red	635	2.1	2.8	1800	
	C-302G	A-302G	GaP	Green	565	2.2	2.8	1600	
	C-302Y	A-302Y	GaAsP/GaP	Yellow	585	2.1	2.8	1500	
	C-302SR	A-302SR	GaAlAs	Super Red	660	1.8	2.2	5000	
	C-362H	A-362H	GaP	Red	700	2.3	2.8	550	D26
	C-362E	A-362E	GaAsP/GaP	Hi.effi Red	635	2.1	2.8	1800	
	C-362G	A-362G	GaP	Green	565	2.1	2.8	1600	
	C-362Y	A-362Y	GaAsP/GaP	Yellow	585	2.1	2.8	1500	
	C-362SR	A-362SR	GaAlAs	Super Red	660	1.8	2.2	5000	

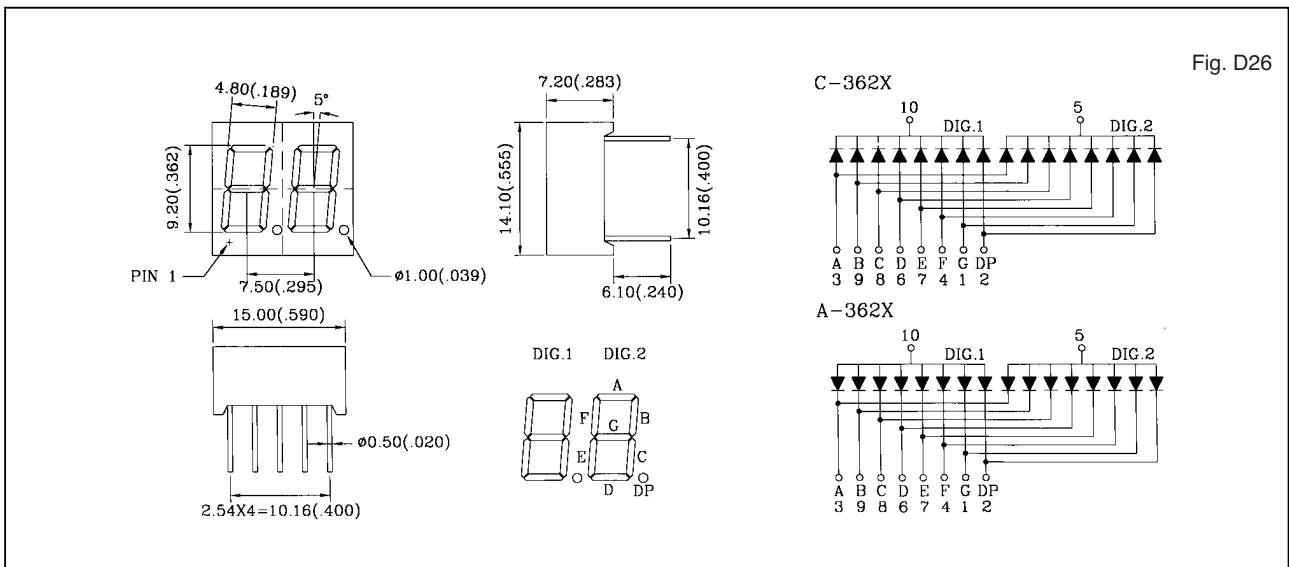
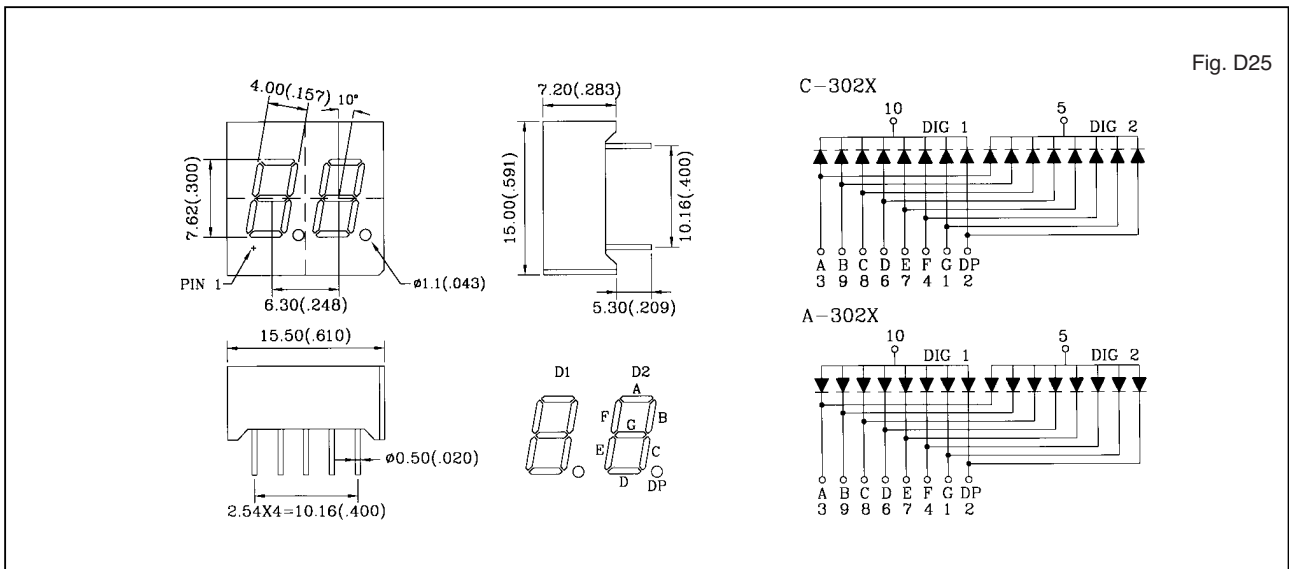

- 1.All dimension are in millimeters (inches).
- 2.Tolerance is ± 0.25 mm (0.01") unless otherwise specified.

C/A-392X, C/A-402X DUAL DIGITS DISPLAY

Shape	Part No.		Chip		Wave Length λ_p (nm)	Electro-Optical Characteristics			Fig.No.
	Common Cathode	Common Anode	Raw Material	Emitted Color		Vf(V)20mA		Iv(ucd)10mA	
						Typ.	Max.	Typ.	
	C-392H	A-392H	GaP	Red	700	2.3	2.8	550	D27
	C-392E	A-392E	GaAsP/GaP	Hi.effi Red	635	2.1	2.8	1800	
	C-392G	A-392G	GaP	Green	565	2.2	2.8	1600	
	C-392Y	A-392Y	GaAsP/GaP	Yellow	585	2.1	2.8	1500	
	C-392SR	A-392SR	GaAlAs	Super Red	660	1.8	2.2	8000	
	C-392LB61	A-392LB61	GaInN/GaN	Blue	462	3.5	4.0	10000	
	C-402H	A-402H	GaP	Red	700	2.3	2.8	650	D28
	C-402E	A-402E	GaAsP/GaP	Hi.effi Red	635	2.1	2.8	2000	
	C-402G	A-402G	GaP	Green	565	2.1	2.8	2000	
	C-402Y	A-402Y	GaAsP/GaP	Yellow	585	2.1	2.8	1600	
	C-402SR	A-402SR	GaAlAs	Super Red	660	1.8	2.2	10000	
	C-402LB61	A-402LB61	GaInN/GaN	Blue	462	3.5	4.0	15000	

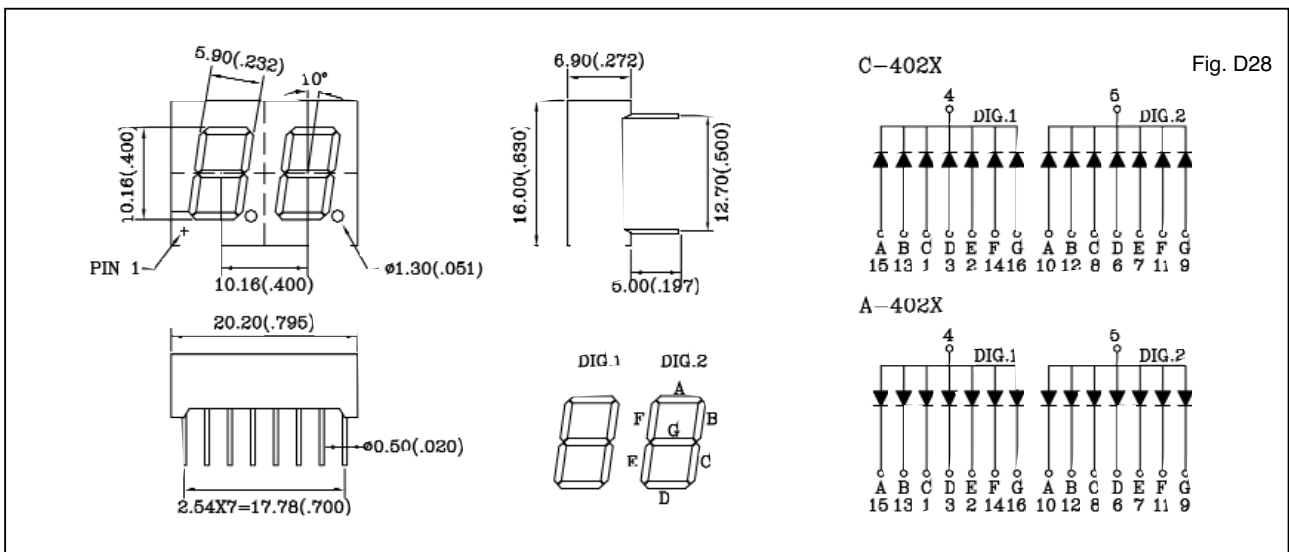
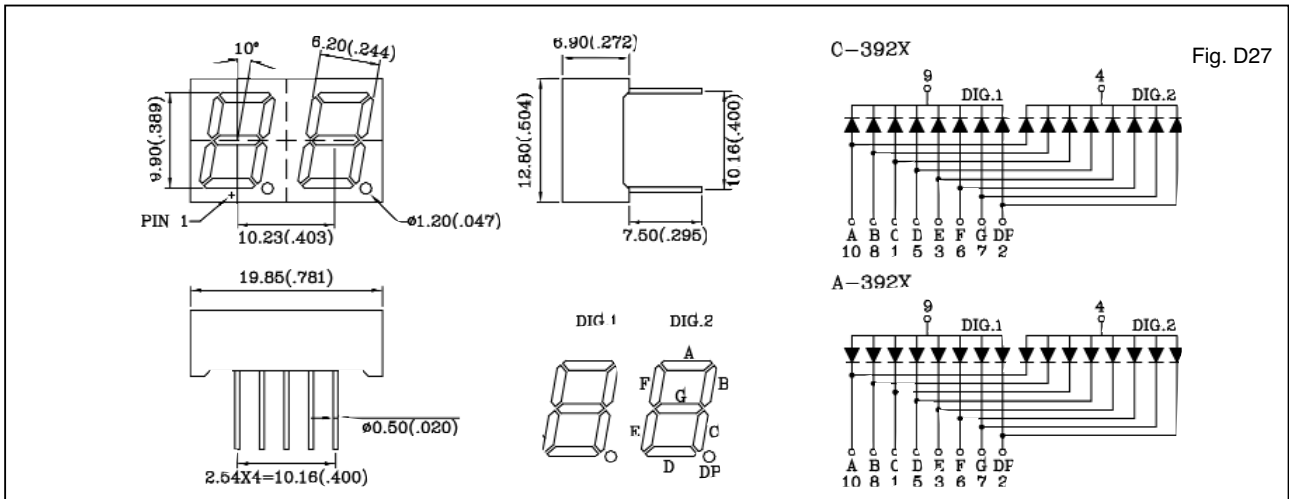

- 1.All dimension are in millimeters (inches).
- 2.Tolerance is ± 0.25 mm (0.01") unless otherwise specified.

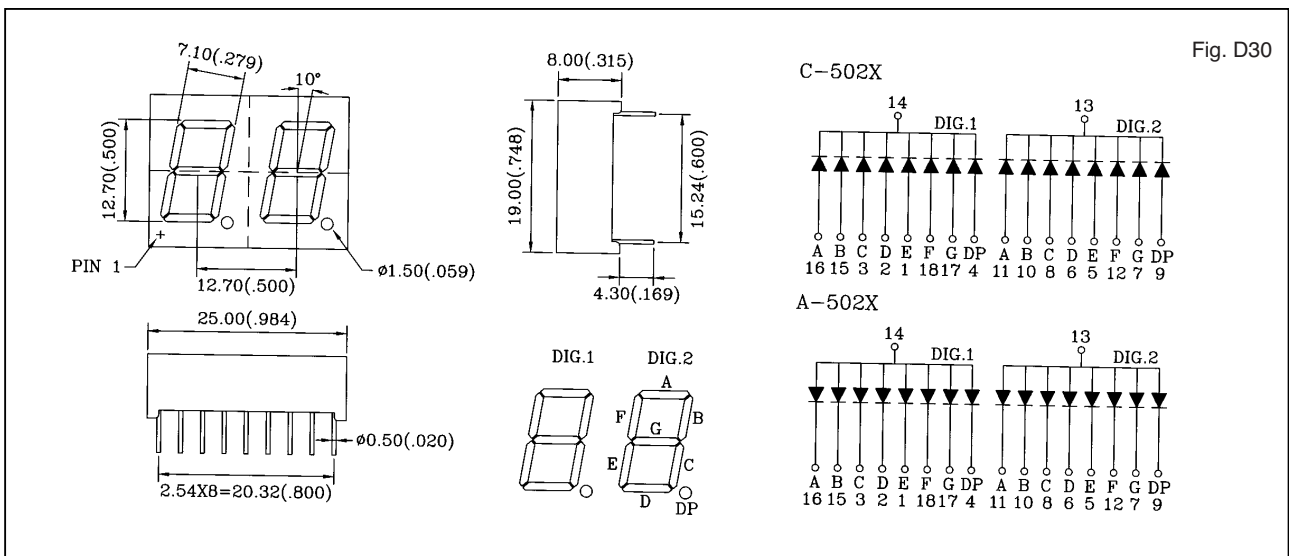
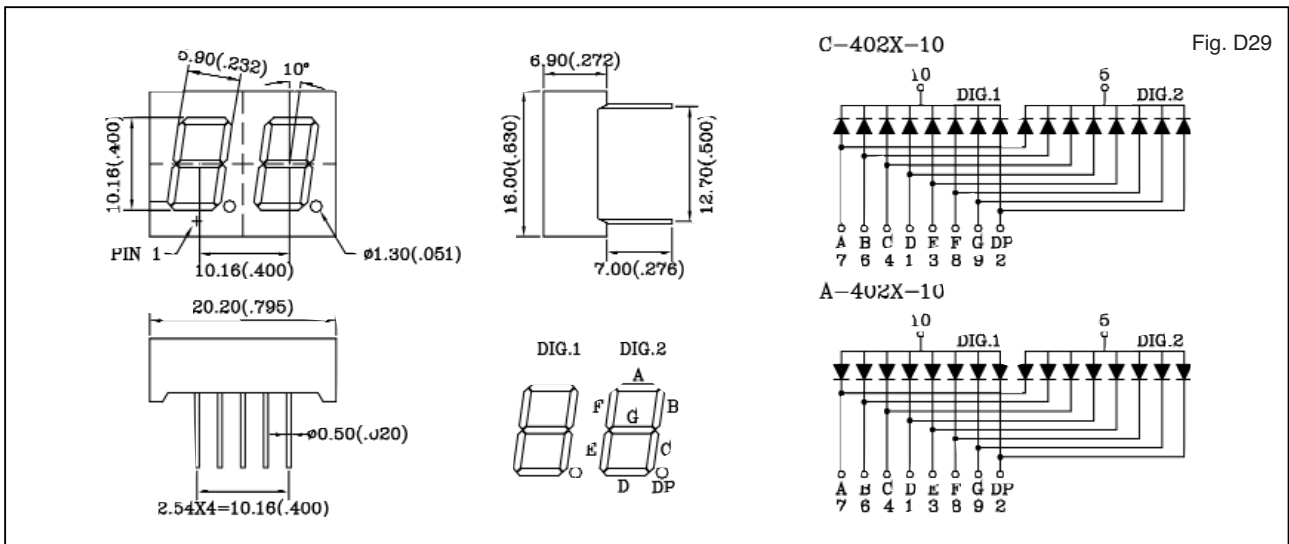

C/A-402X, C/A-502X DUAL DIGITS DISPLAY

Shape	Part No.		Chip		Wave Length λ p(nm)	Electro-Optical Characteristics			Fig.No.
	Common Cathode	Common Anode	Raw Material	Emitted Color		Vf(V)20mA		Iv(ucd)10mA	
						Typ.	Max.	Typ.	
	C-402H-10	A-402H-10	GaP	Red	700	2.3	2.8	650	D29
	C-402E-10	A-402E-10	GaAsP/GaP	Hi.effi Red	635	2.1	2.8	2000	
	C-402G-10	A-402G-10	GaP	Green	565	2.2	2.8	2000	
	C-402Y-10	A-402Y-10	GaAsP/GaP	Yellow	585	2.1	2.8	1600	
	C-402SR-10	A-402SR-10	GaAlAs	Super Red	660	1.8	2.2	10000	
	C-502H	A-502H	GaP	Red	700	2.3	2.8	650	D30
	C-502E	A-502E	GaAsP/GaP	Hi.effi Red	635	2.1	2.8	2000	
	C-502G	A-502G	GaP	Green	565	2.1	2.8	2000	
	C-502Y	A-502Y	GaAsP/GaP	Yellow	585	2.1	2.8	1600	
	C-502SR	A-502SR	GaAlAs	Super Red	660	1.8	2.2	21000	
	C-502UB	A-502UB	GaN/GaN	Super Blue	462	3.5	4.0	28000	



- 1.All dimension are in millimeters (inches).
- 2.Tolerance is ± 0.25 mm (0.01") unless otherwise specified.

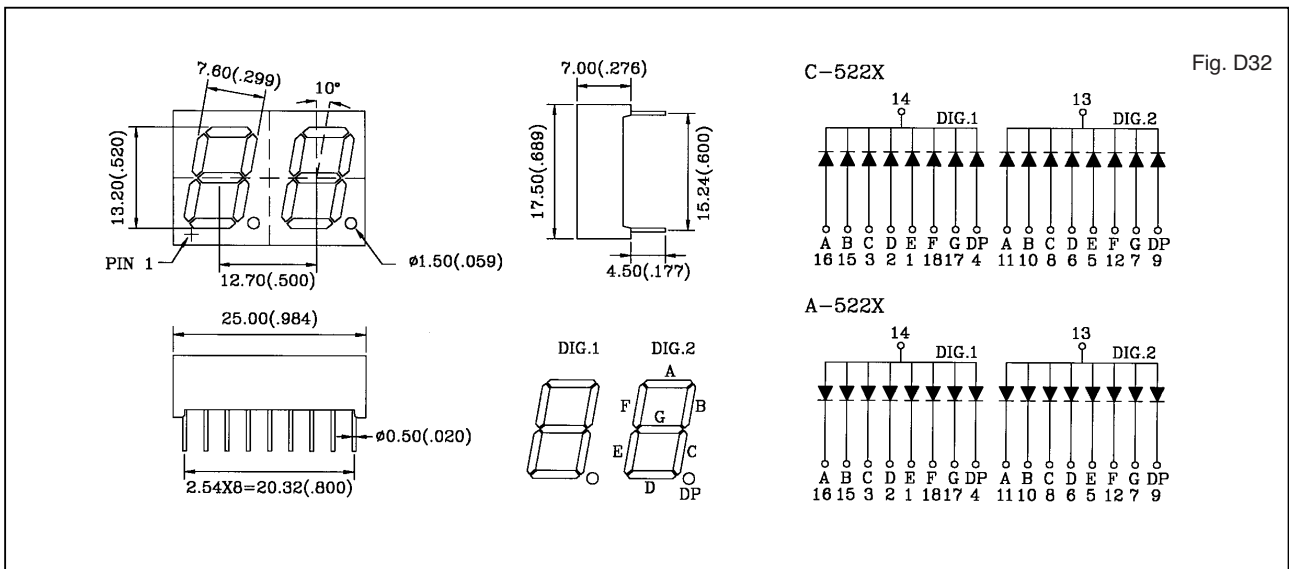
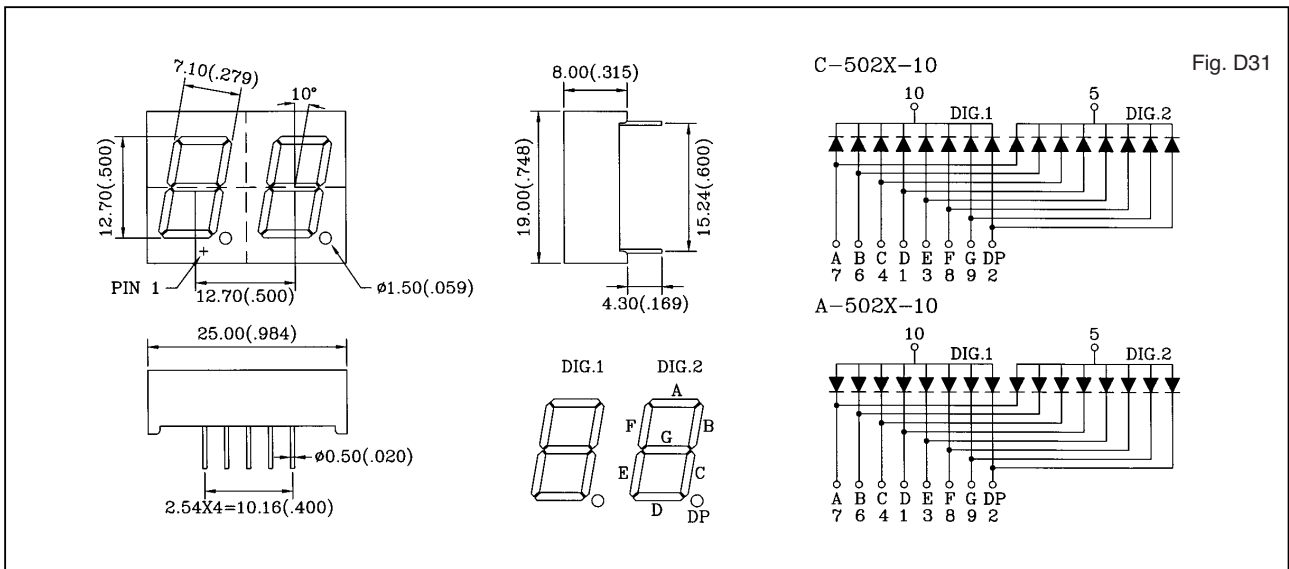

C/A-502X-10, C/A-522X DUAL DIGITS DISPLAY

Shape	Part No.		Chip		Wave Length λ p(nm)	Electro-Optical Characteristics			Fig.No.
	Common Cathode	Common Anode	Raw Material	Emitted Color		Vf(V)20mA		Iv(ucd)10mA	
						Typ.	Max.	Typ.	
	C-502H-10	A-502H-10	GaP	Red	700	2.3	2.8	650	D31
	C-502E-10	A-502E-10	GaAsP/GaP	Hi.effi Red	635	2.1	2.8	2000	
	C-502G-10	A-502G-10	GaP	Green	565	2.2	2.8	2000	
	C-502Y-10	A-502Y-10	GaAsP/GaP	Yellow	585	2.1	2.8	1600	
	C-502SR-10	A-502SR-10	GaAlAs	Super Red	660	1.8	2.2	21000	
	C-522H	A-522H	GaP	Red	700	2.3	2.8	650	D32
	C-522E	A-522E	GaAsP/GaP	Hi.effi Red	635	2.1	2.8	2000	
	C-522G	A-522G	GaP	Green	565	2.1	2.8	2000	
	C-522Y	A-522Y	GaAsP/GaP	Yellow	585	2.1	2.8	1600	
	C-522SR	A-522SR	GaAlAs	Super Red	660	1.8	2.2	21000	



- 1.All dimension are in millimeters (inches).
- 2.Tolerance is ± 0.25 mm (0.01") unless otherwise specified.

C/A-562X, C/A-562X-10 DUAL DIGITS DISPLAY

Shape	Part No.		Chip		Wave Length λ_p (nm)	Electro-Optical Characteristics			Fig.No.
	Common Cathode	Common Anode	Raw Material	Emitted Color		Vf(V)20mA		Iv(ucd)10mA	
						Typ.	Max.	Typ.	
	C-562H	A-562H	GaP	Red	700	2.3	2.8	650	D33
	C-562E	A-562E	GaAsP/GaP	Hi.effi Red	635	2.1	2.8	2000	
	C-562G	A-562G	GaP	Green	565	2.2	2.8	2000	
	C-562Y	A-562Y	GaAsP/GaP	Yellow	585	2.1	2.8	1600	
	C-562SR	A-562SR	GaAlAs	Super Red	660	1.8	2.2	21000	
	C-562H-10	A-562H-10	GaP	Red	700	2.3	2.8	650	D34
	C-562E-10	A-562E-10	GaAsP/GaP	Hi.effi Red	635	2.1	2.8	2000	
	C-562G-10	A-562G-10	GaP	Green	565	2.1	2.8	2000	
	C-562Y-10	A-562Y-10	GaAsP/GaP	Yellow	585	2.1	2.8	1600	
	C-562SR-10	A-562SR-10	GaAlAs	Super Red	660	1.8	2.2	21000	

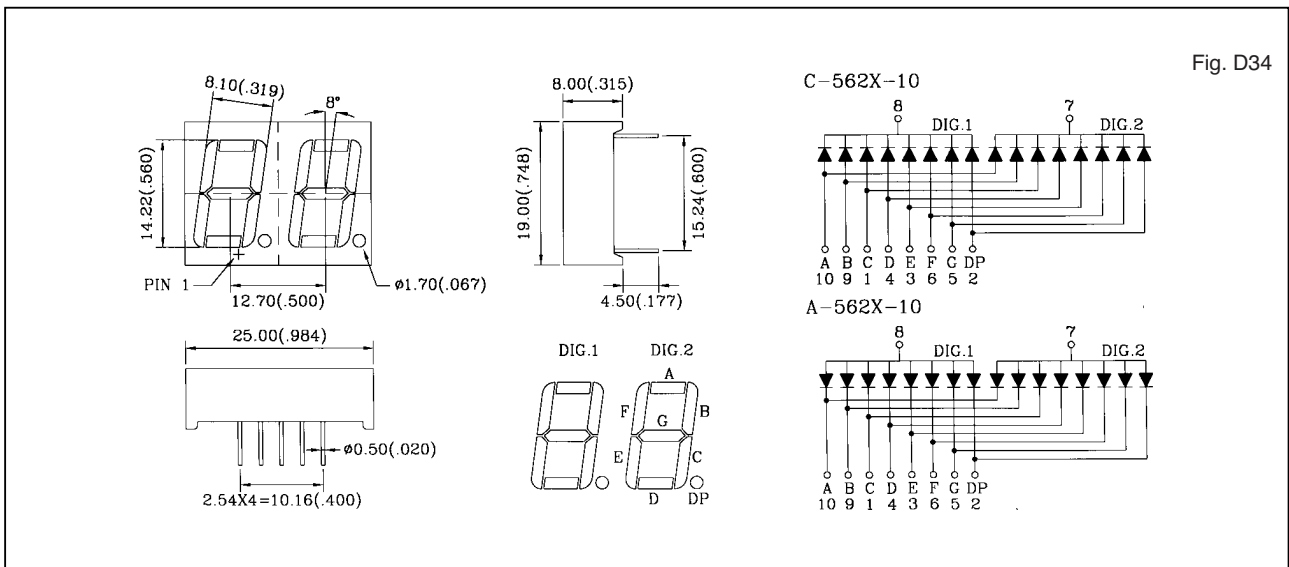
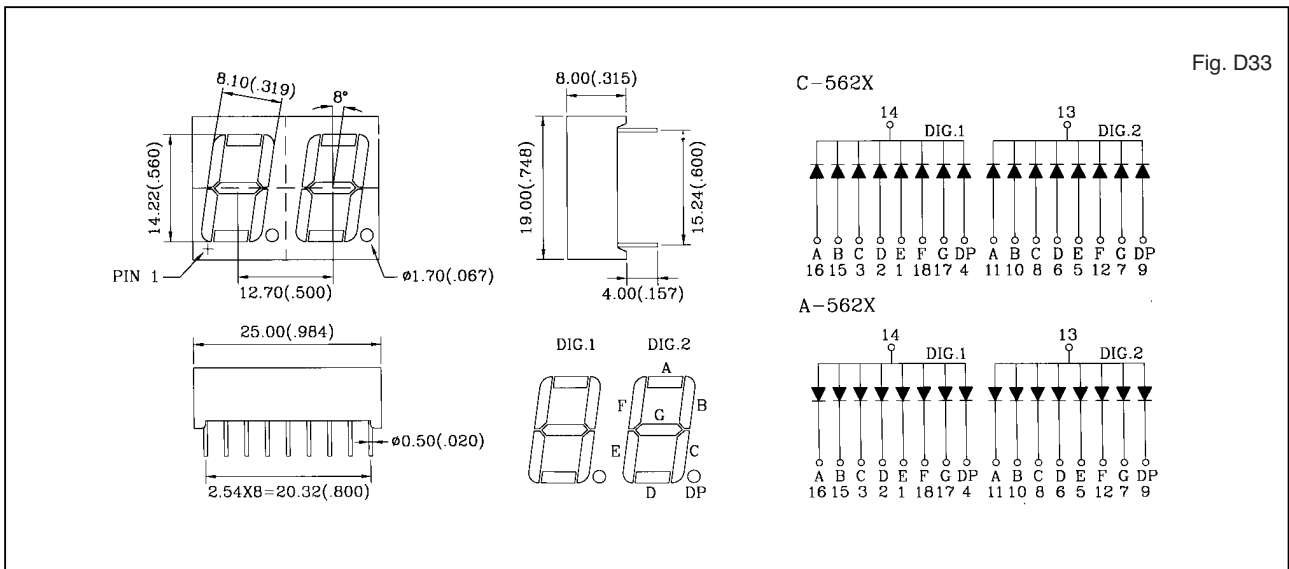

- 1.All dimension are in millimeters (inches).
- 2.Tolerance is ± 0.25 mm (0.01") unless otherwise specified.